

PARCO, INC.

T-SLOT INNOVATION SOLUTIONS CATALOG

Non-magnetic. Aesthetically pleasing. Easy to configure & re-configure. No welding = no heat stress or warping.



Your Best Alternative For T-Slotted Aluminum Extrusion

PRODUCT OVERVIEW

1-800-817-0617

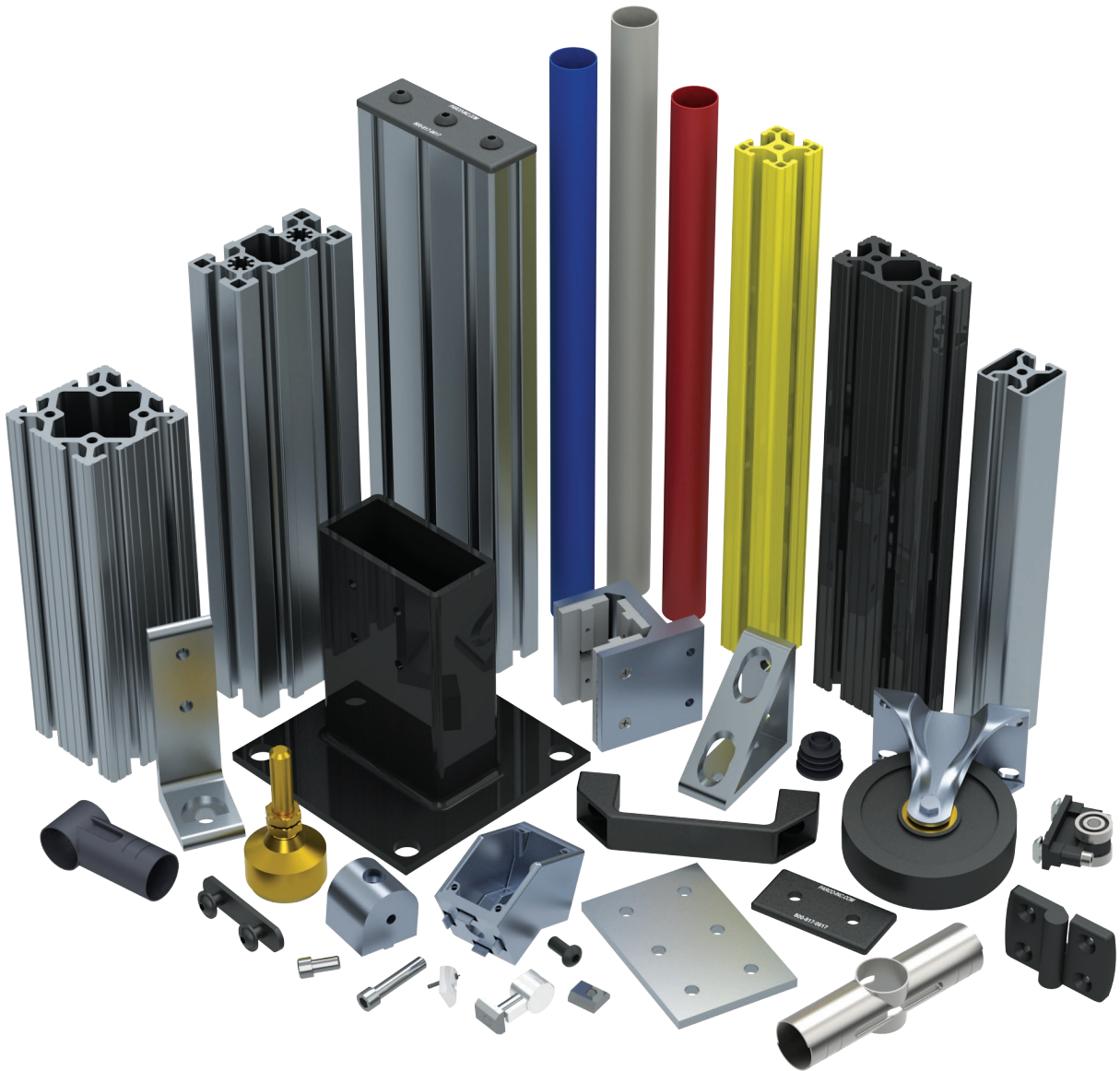

www.parco-inc.com

REV 2021

Fractional

Our business revolves around t-slotted aluminum extrusion – its design, fabrication, and use in innovative products! We custom create many solutions for the manufacturing, automotive, and medical industries. Our fractional profiles are augmented and supported by thousands of component parts including; fasteners, joining plates, brackets, etc. This allows us to build and design unlimited project applications that are strong and flexible.

Stock Lengths - 240", 120", 92" or Cut to Length

Some Extrusions Vary in Size. Check Catalog for Exact Sizes.





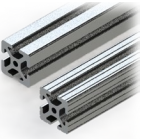





* Extrusions in Stock for Quick Delivery

S - Smooth Extrusion
 G - Grooved Extrusion
 BA - Black Anodized
 YEL - Safety Yellow
 * Extrusions In Stock







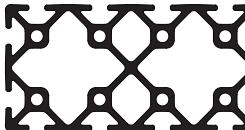











1" Profile

T-Slot Sizes - 6mm or 1/4-20 T-Nut + Bolt

						
1" x .5" E1050S	2" x .5" E2012S	1" x 1" * E1010S * E1010G E1010S-BA E1010G-BA	1" x 1" monoslot * E1001S	1" x 1" bislot adj * E1002S	1" x 1" bislot opp * E1004S	1" x 1" trislot * E1003S
						
1" x 1" QR * E1012S	1" x 2" * E1020S * E1020G * E1020S-BA	1" x 3" * E1030S E1030S-BA	2" x 2" * E2020S * E2020G E2020S-BA	2" x 4" * E2040S		

1.5" Profile

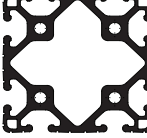
T-Slot Sizes - 8mm or 5/16-18 T-Nut + Bolt

						
1.5" x .75" * E1575S	3" x .75" * E3075S	1.5" x 1.5" * E1515S * E1515G E1515S-BA	1.5" x 1.5" L * E1515LS * E1515LG * E1515LS-BA	1.5" x 1.5" UL * E1515ULS * E1515ULG E1515ULS-YEL	1.5" monoslot * E1501S E1501S-BA	1.5" bislot adj * E1502S E1502S-BA
						
1.5" bislot opp * E1504S E1504S-BA	1.5" x 1.5" trislot * E1503S E1503S-BA	1.5" x 1.5" QR * E1517S	1.5" x 3" * E1530S * E1530G E1530S-BA	1.5" x 3" L * E1530LS * E1530LG E1530LS-BA	1.5" x 3" UL * E1530ULS	
						
1.5" x 4.5" E1545S	3" x 3" * E3030S * E3030G E3030S-BA	3" x 3" L * E3030LS * E3030LG E3030LS-BA	3" x 6" * E3060S			

Yellow Powder Coated
 & Black Anodized
 available upon request

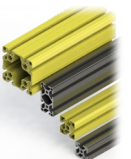

FASTENER APPLICATION TEST

FASTENER	E1010G		E1515LS		E1515L	
	A (lbs)	B	A (lbs)	B	A (lbs)	B
1	500	180 in/lbs	950	540 in/lbs	950	700 in/lbs
2	900	250 in/lbs	1,200	1,150 in/lbs	1,200	2,000 in/lbs
3	450	325 in/lbs	1,000	680 in/lbs	1,000	1,150 in/lbs
4	175	400 in/lbs	225	1,000 in/lbs	225	1,100 in/lbs
5	175	500 in/lbs	250	1,200 in/lbs	250	1,260 in/lbs
6	325	180 in/lbs	375	500 in/lbs	575	500 in/lbs
7	325	260 in/lbs	375	500 in/lbs	575	500 in/lbs

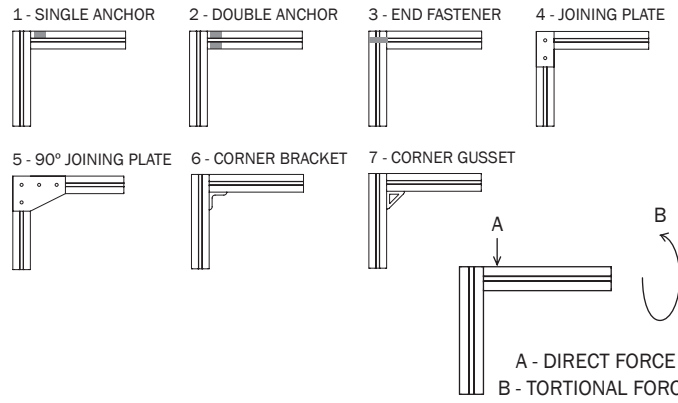

* All forces are approximate.

FASTENERS



End Fasteners



Anchor Fasteners



Central Connectors



Economy & Standard T-nuts



Drop-in T-nuts & Z-nuts

BRACKETS



Brackets



Corner Gussets

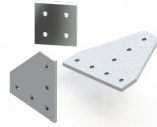

Joining Plates

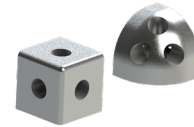

Tri-Corners



Black Anodized Brackets

HARDWARE



Handles



Hinges



Economy Floor Mount

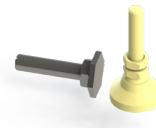

Leveling Feet



Casters

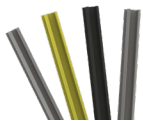

T-Slot Cover



Pivot Joints



Latches



End Caps

PANEL ACCESSORIES



Panels

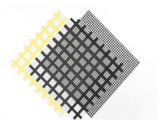

Wire Mesh



Panel Gasket

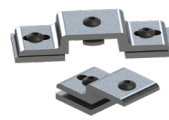

Mesh Retainers

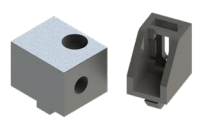

Panel Mounts

LINEAR MOTION



Bearings

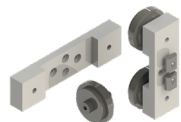

Roller Wheels

Metric

We also offer 30mm, 40mm and 45mm T-Slotted aluminum extrusions. As always, we carry all of the structural components needed to build any number of solutions that are aesthetically pleasing and re-configurable.

Stock Lengths - 2300mm, 3048mm, 6000mm or Cut To Length

* Extrusions In Stock For Quick Delivery

S - Smooth Extrusion
 BA - Black Anodized
 YEL - Safety Yellow
 * Extrusions In Stock

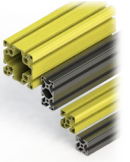

30, 40, 45 Profile T-Slot Sizes 8mm (30 & 40 series), 10mm (45 series)



30 x 30 mm
 * E30-3030
 E30-3030-BA

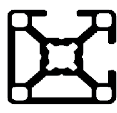

30 x 30 mm bislot adj
 * E30-3030-2SA

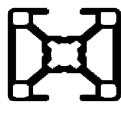

30 x 30 mm bislot opp
 * E30-3030-2S



30 x 30 mm WG30
 * E30-3030-WG30



30 x 30 mm WG40
 E30-3030-WG40



30 x 45 FG30
 E30-3045-30



30 x 45 FG40
 E30-3045-40



30 x 45 mm C-channel
 E30-3035C



30 x 60 mm R
 E30-3060R

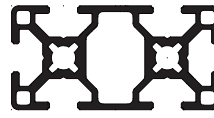

30 x 60 mm
 * E30-3060



60 x 60 mm
 E30-6060

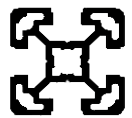

40 x 40 mm Slot 10
 E40-4040-10S

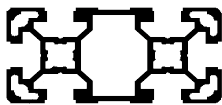

40 x 80 mm Slot 10
 E40-4080-10S



40 x 40 mm UL
 * E40-4040UL



40 x 40 mm L
 * E40-4040L
 E40-4040L-BA



40 x 40 mm
 * E40-4040
 E40-4040-BA



40 x 40 mm monoslot
 * E40-4001



40 x 40 mm bislot adj
 * E40-4002



40 x 40 mm trislot
 * E40-4003



40 x 40 mm bislot opp
 * E40-4004



40 x 45 mm monoslot
 E40-4045L-01



40 x 45 mm bislot
 E40-4045L-02

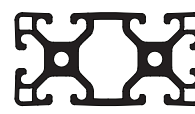

40 x 80 mm UL
 * E40-4080UL
 E40-4080-BA



40 x 80 mm L
 * E40-4080L
 E40-4080L-BA



40 x 80 mm
 * E40-4080

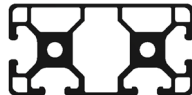

40 x 80 mm L
 E40-4084L

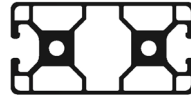

40 x 80 mm L bislot opp
 E40-4085L



40 x 120 mm
 E40-4012



80 x 80 mm
 * E40-8080

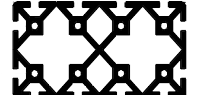

80 x 160 mm
 E40-8016



22.5 x 45 mm
 E45-22.545



45 x 45 mm
 * E45-4545L



45 x 45 mm
 * E45-4545

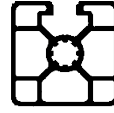

45 x 45 mm monoslot
 E45-4545-01

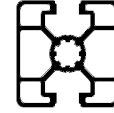

45 x 45 mm bislot opp
 E45-4545-2S

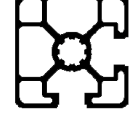

45 x 45 mm bislot
 E45-4545-2SA
 * E45-4545L-YEL

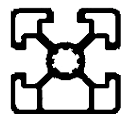

45 x 45 mm trislot
 E45-4545-03



45 x 45 mm R
 E45-4545R



45 x 45 mm R
 E45-4545HR

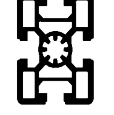

45 x 60 mm
 E45-4560



45 x 90 mm L
 * E45-4590L

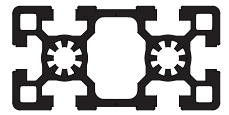

45 x 90 mm
 * E45-4590
 E45-4590-BA



60 x 60 mm
 E45-6060L



60 x 60 mm
 E45-6060



60 x 90 mm
 E45-6090



90 x 90 mm
 * E45-9090
 E45-9090-BA

FASTENER APPLICATION TEST

FASTENER	E1010G		E1515LS		E1515L	
	A (lbs)	B	A (lbs)	B	A (lbs)	B
1	500	180 in/lbs	950	540 in/lbs	950	700 in/lbs
2	900	250 in/lbs	1,200	1,150 in/lbs	1,200	2,000 in/lbs
3	450	325 in/lbs	1,000	680 in/lbs	1,000	1,150 in/lbs
4	175	400 in/lbs	225	1,000 in/lbs	225	1,100 in/lbs
5	175	500 in/lbs	250	1,200 in/lbs	250	1,260 in/lbs
6	325	180 in/lbs	375	500 in/lbs	575	500 in/lbs
7	325	260 in/lbs	375	500 in/lbs	575	500 in/lbs

* All forces are approximate.

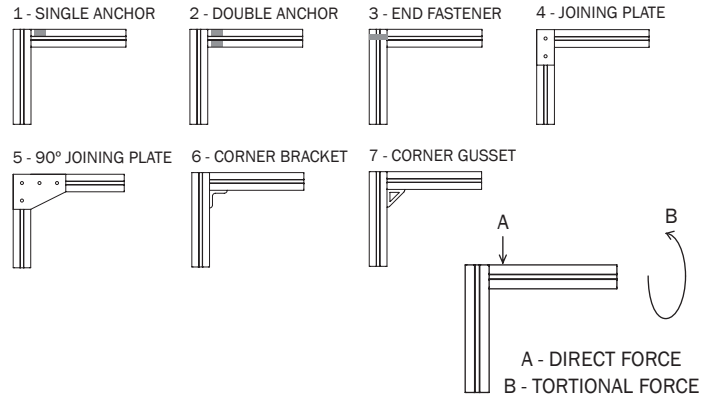

FASTENERS



BRACKETS



HARDWARE

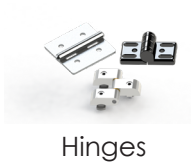

PANEL ACCESSORIES

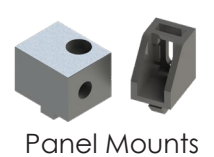
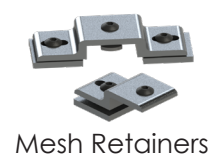
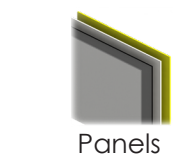

LINEAR MOTION

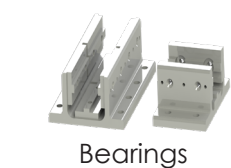

Fastener Installation

Anchor Fastener (Counterbore Machining Required)

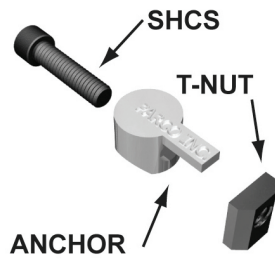

ANCHOR FASTENERS CONSIST OF THREE PARTS:

1. T-NUT
2. ANCHOR
3. SHCS

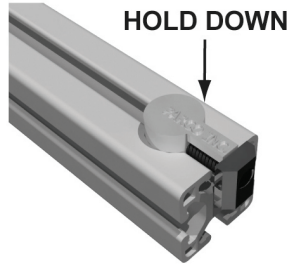

INSERT THE SHCS THROUGH THE ANCHOR AND PARTIALLY INTO THE T-NUT. PLACE THE ANCHOR ASSEMBLY INTO THE COUNTERBORE HOLE IN THE EXTRUSION.

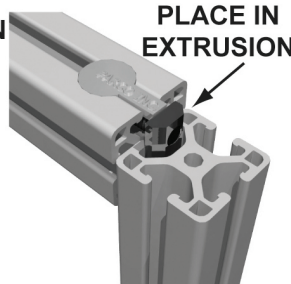

LINE UP THE ANCHORED EXTRUSION WITH THE JOINING EXTRUSION AND INSERT THE T-NUT INTO THE T-SLOT.



WHEN EXTRUSION IS PROPERLY IN PLACE TIGHTEN SHCS WITH A T-HANDLE HEX WRENCH UNTIL CONNECTION IS SOUND.

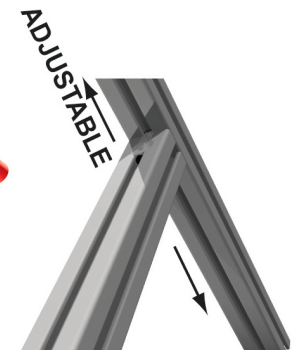

EXTRUSION CAN BE MOUNTED ANYWHERE ALONG JOINING EXTRUSION WITH ANCHOR FASTENER CONNECTION.

End Fastener (Access Hole Machining Required)

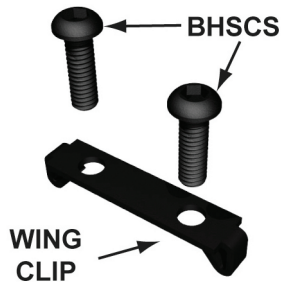

END FASTENERS CONSIST OF TWO TYPES OF PARTS:

1. BHSCS (1 FOR SINGLE)
2. WING CLIP (DOUBLE OR SINGLE)

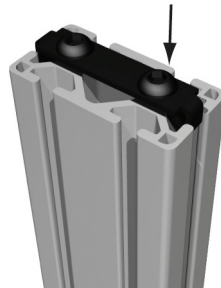

INSERT THE BHSCS'S THROUGH THE WING CLIP AND INTO THE TAPPED END OF THE EXTRUSION. DO NOT TIGHTEN.



TWO ACCESS HOLES IN THE JOINING EXTRUSION ARE REQUIRED FOR DOUBLE END FASTENERS (ONLY ONE IS NEEDED FOR SINGLE END FASTENERS)

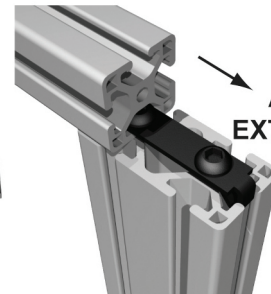

SLIDE THE JOINING EXTRUSION ONTO THE WING CLIP UNTIL THE ACCESS HOLES ARE ALIGNED WITH THE BHSCS'S.



PLACE A T-HANDLE HEX WRENCH INTO THE ACCESS HOLE UNTIL CONTACT IS MADE WITH THE BHSCS. TIGHTEN UNTIL THE CONNECTION IS SOUND.

Corner Gusset (No Machining Required)

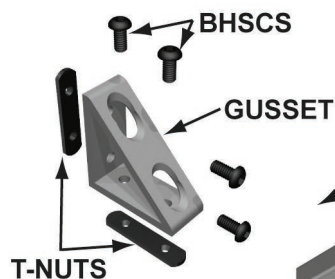

CORNER GUSSETS ARE COMPRISED THREE TYPES OF PARTS:

1. (4) BHSCS
2. (2) DOUBLE ECON T-NUTS
3. 4 HOLE CORNER GUSSET

*DIFFERENT TYPES OF GUSSETS ARE AVAILABLE.

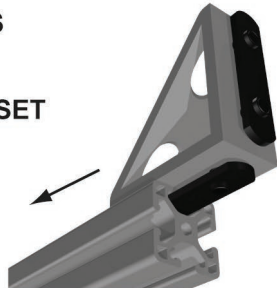

INSERT THE BHSCS'S THROUGH THE GUSSET AND LOOSELY INTO THE T-NUTS. BEGIN SLIDING THE GUSSET ONTO THE EXTRUSION WITH THE T-NUT IN THE T-SLOT.

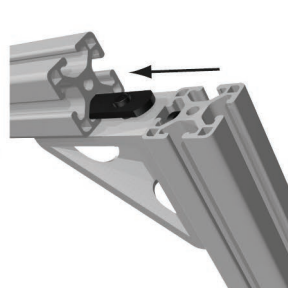

INSERT THE T-NUT ON ADJACENT SIDE OF THE GUSSET INTO THE T-SLOT OF THE JOINING EXTRUSION.



WHEN EXTRUSION IS PROPERLY IN PLACE TIGHTEN THE BHSCS'S WITH A T-HANDLE HEX WRENCH UNTIL THE CONNECTION IS SECURE.

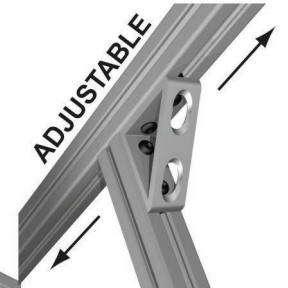

EXTRUSION CAN BE MOUNTED ANYWHERE ALONG THE JOINING PROFILE WITH THE GUSSET CONNECTION.

Custom Built To Your Specifications

We offer solutions for many applications in the medical, automotive, and manufacturing industries – solutions that increase productivity, product workflow, and the safety of your valued employees. From start to finish, we can provide you with a full-service experience. Need help with a custom project? No problem! Our engineering team specializes in creating custom designs utilizing our unique Solidworks plug-in. We offer this service free of charge! From there, our fabrication and assembly departments will cut, machine, and build to your exact specifications.



Mobile Printer Stands

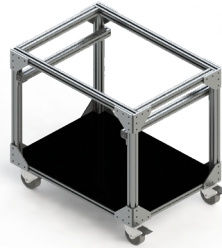

Mobile Carts



Machine Enclosures



Magnetic Dry Erase Boards



Ergonomic Workstations



Platforms & Stairs

Pre-Engineered Machine Safety Guarding

With Parco's Pre-Engineered Machine Safety Guarding, the majority of the work is done for you. Simply measure the outline of the area you need to guard and decide what style you need. Add up the LNFT with your door options and in seconds you have the price for your system. Parco can have your product to you within days. The guarding is easy to install too. An average 14" x 18" perimeter guard will only take approximately 3-4 hours to fully install on your plant floor. This saves you time and, more importantly, money.

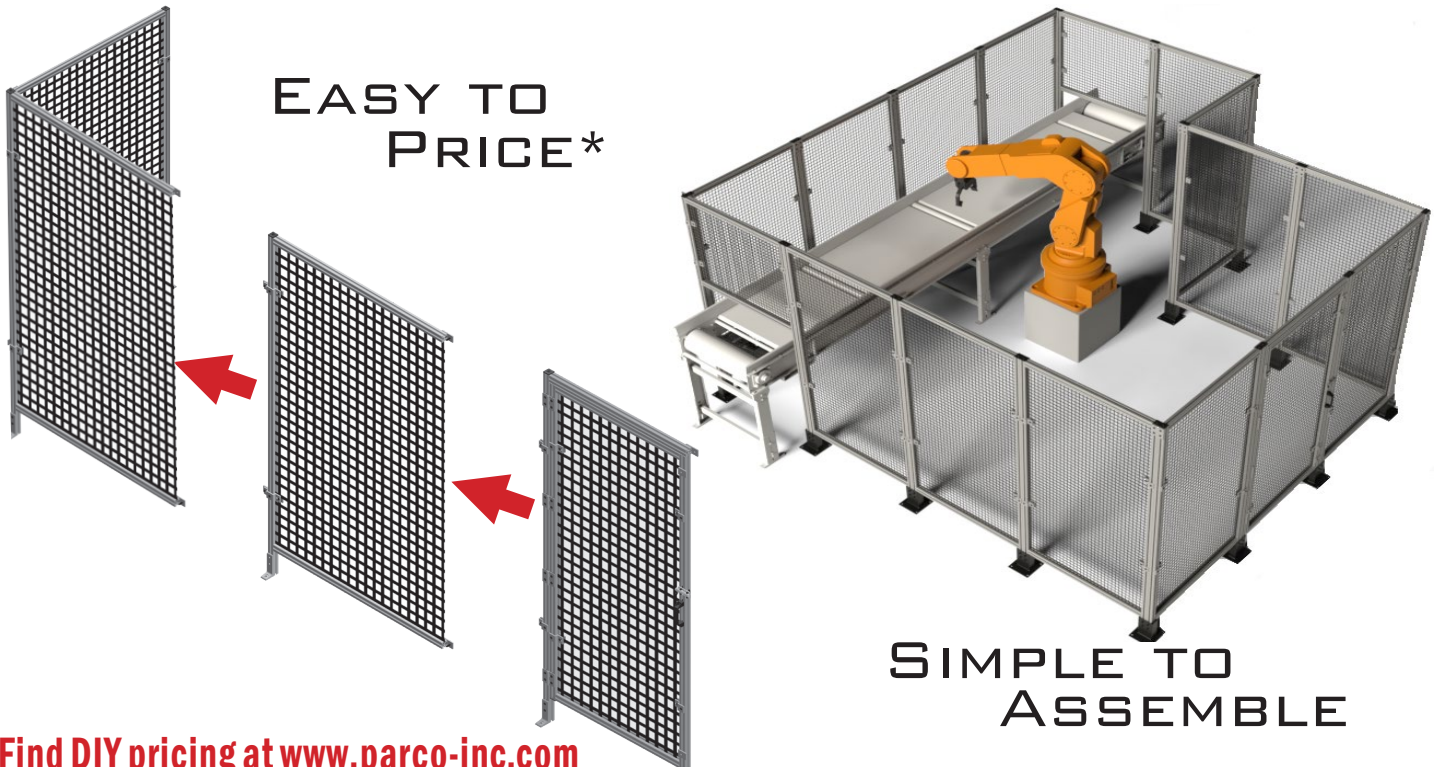

***Find DIY pricing at www.parco-inc.com**

THE QUICKEST MACHINE GUARD TO PRICE AND INSTALL IN THE INDUSTRY!

